

C\*8PCS

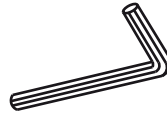

D\*16PCS  
φ6\*25



E\*2PC  
M4\*70mm



F\*16PCS  
φ32mm

### Step 1

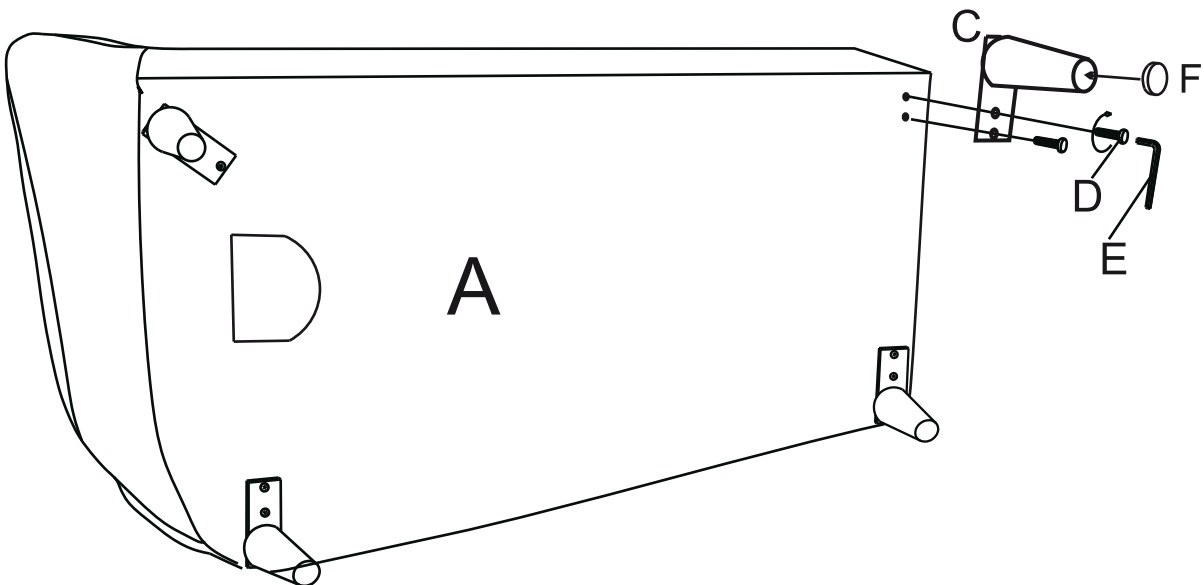
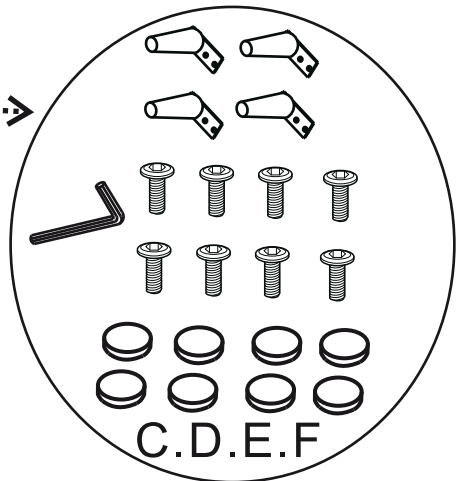
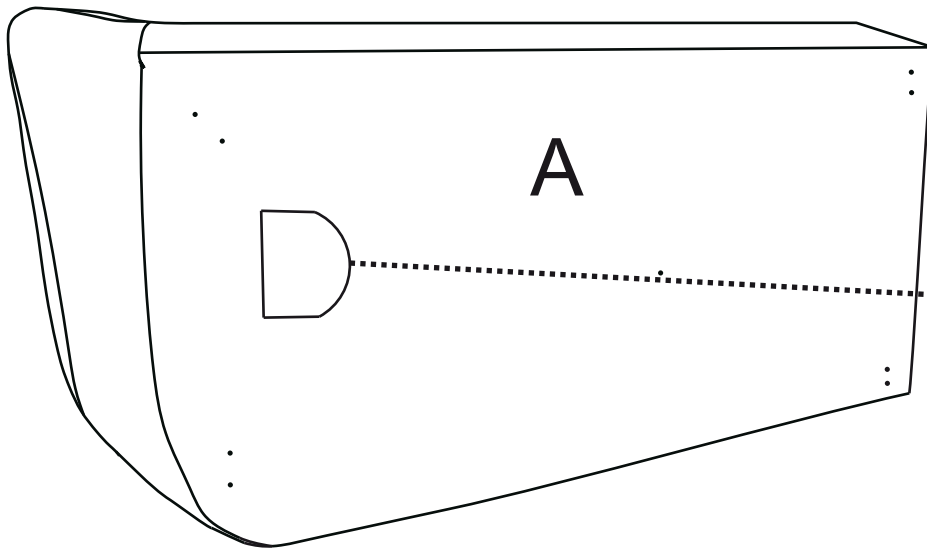

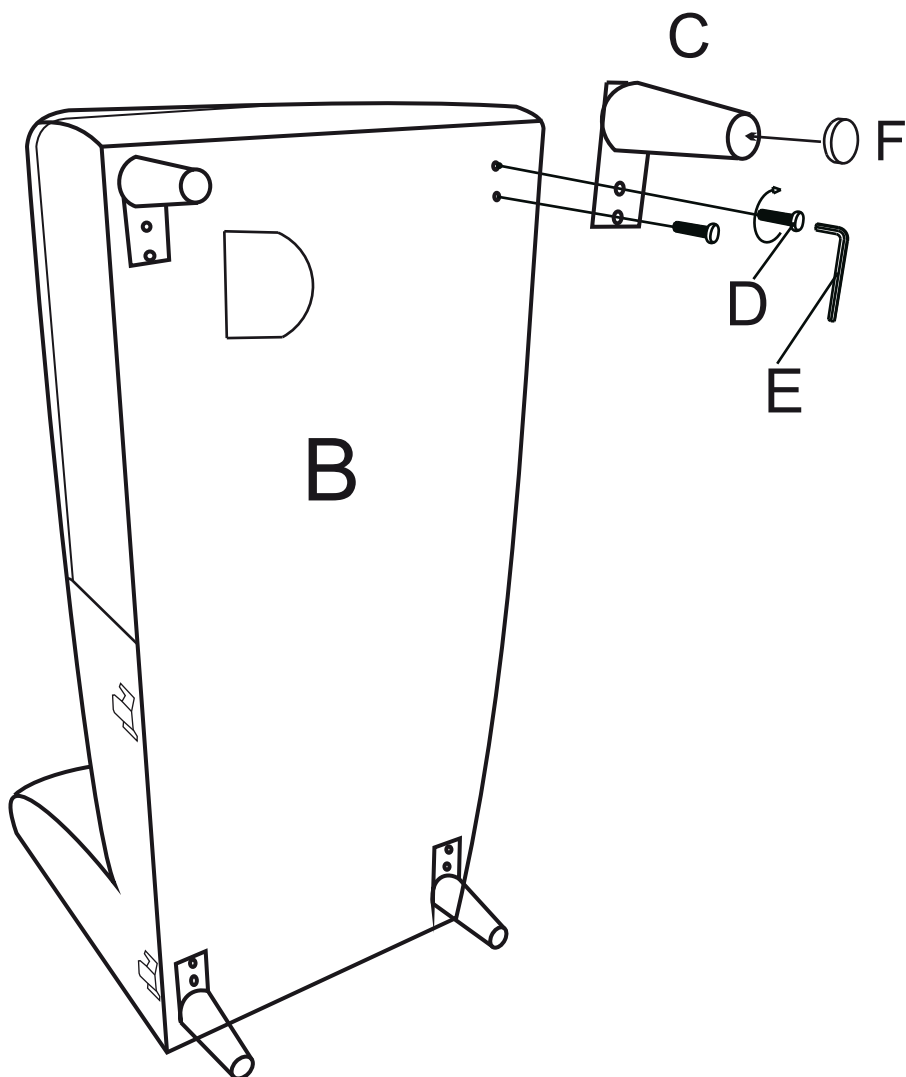
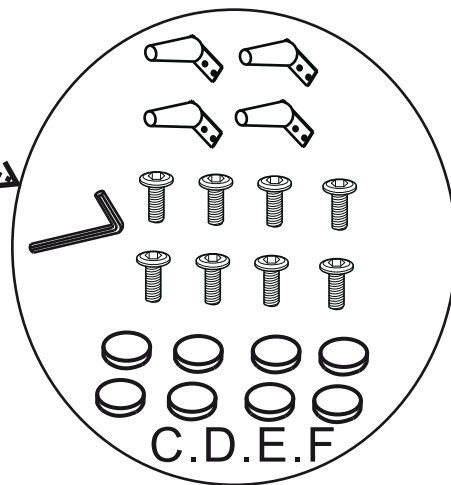
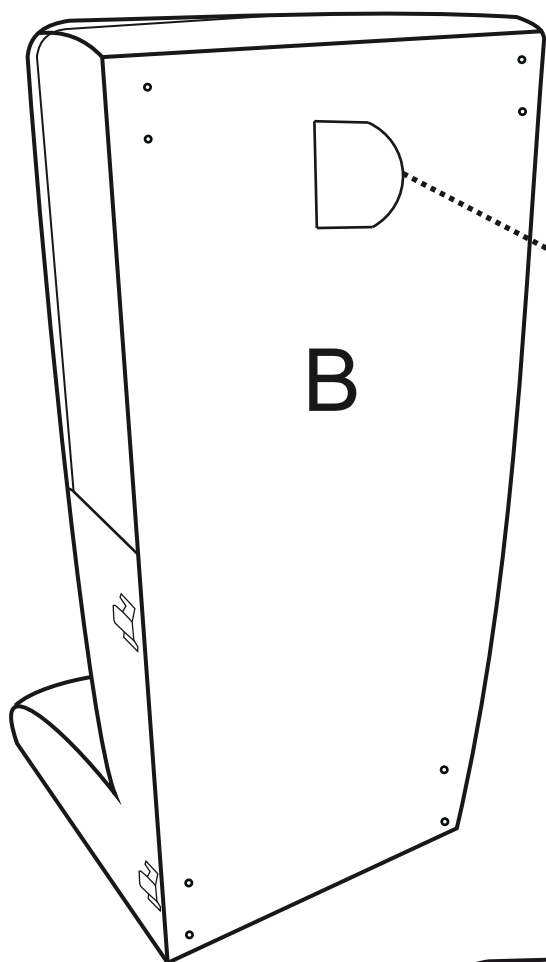

---

Step 3

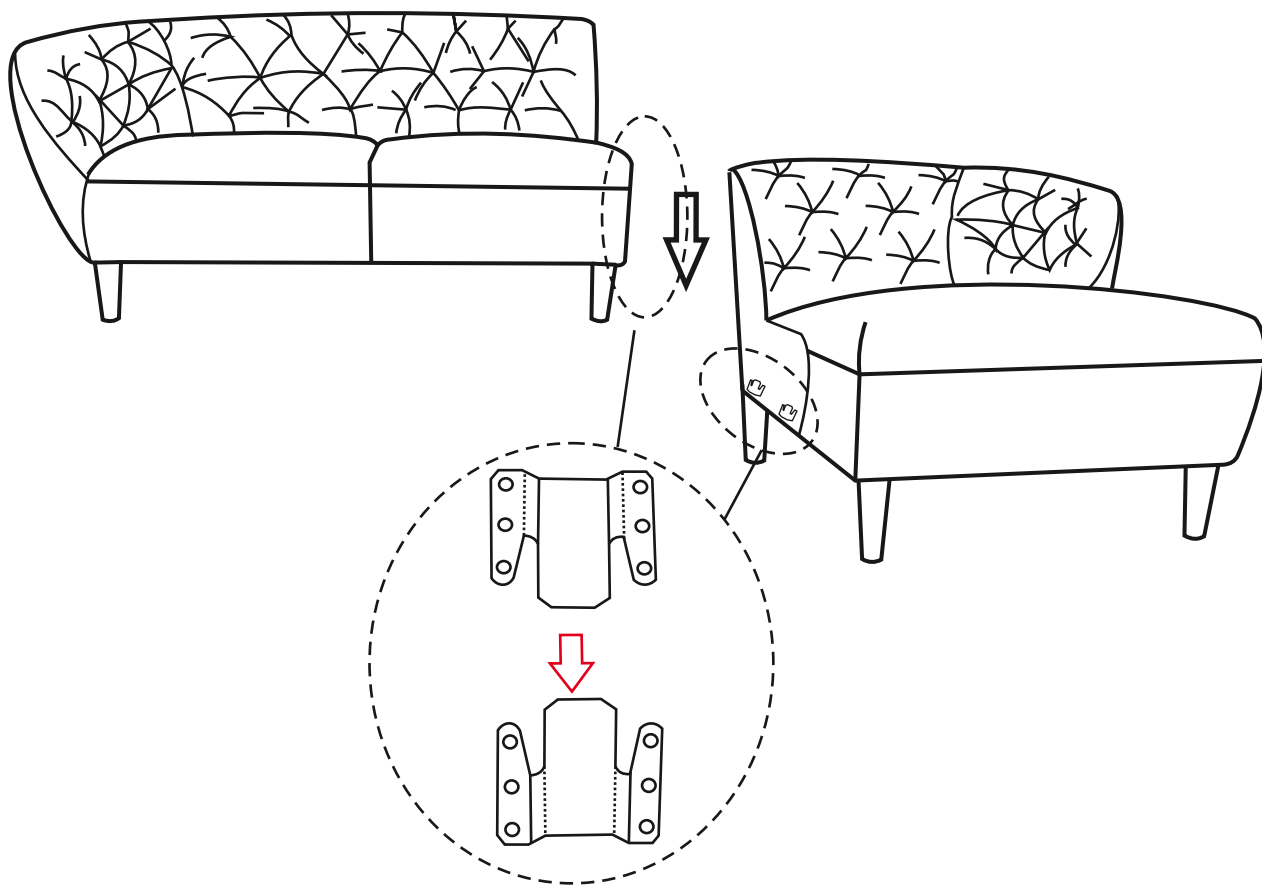

---

Step 4

